

**TECHNICKÝ A ZKUŠEBNÍ ÚSTAV
STAVEBNÍ PRAHA, s.p.**

Prosecká 811/76a
CZ-190 00 Praha 9
Tel.: +42 286 019 412
Fax: +42 286 883 897
Internet: www.tzus.cz

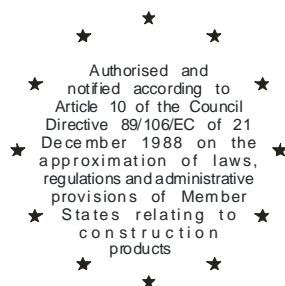

MEMBER OF EOTA

European Technical Approval

ETA-11/0444

(English language translation, the original version is in Czech language)

Obchodní název
Trade name

ECO-FIRST POLYVALENT

Držitel schválení
Holder of approval

SCELL-IT
329, rue de l'industrie
59113 Seclin
France

Typ a použití výrobku
*Generic type and use
of construction product*

Chemická injektovaná kotva do netrhlinového betonu o velikosti M8, M10, M12, M16, M20 a M24
Bonded injection type anchor for non-cracked concrete: sizes M8, M10, M12, M16, M20, M24

Platnost od do
Validity from to

17.10.2011
10.10.2016

Výrobna
Manufacturing plant

SCELL-IT Plant 1
Germany

Toto evropské technické schválení obsahuje
This European technical approval contains

15 stran včetně 8 příloh
15 pages including 8 Annexes



European Organisation for Technical Approvals
Evropská organizace pro technické schvalování

I. LEGAL BASES AND GENERAL CONDITIONS

1. This European Technical Approval is issued by the Technical and Test Institute for Construction Prague (Technický a zkušební ústav stavební Praha, s.p.) in accordance with:
 - Council Directive 89/106/EEC of 21 December 1988 on the approximation of laws, regulations and administrative provisions of Member States relating to construction products¹, modified by the Council Directive 93/68/EEC²; and Regulation (EC) No.1882/2003 of the European Parliament and of the Council³
 - the Government Decree No. 190/2002 Collection of Laws⁴, as amended
 - Common Procedural Rules for Requesting, Preparing and the Granting of European Technical Approvals set out in the Annex to Commission Decision 94/23/EC⁵;
 - Guideline for European Technical Approval of „Metal Anchors for use in Concrete“, ETAG 001, edition 1997, Part 1 ‘Anchors in general’ and Part 5 ‘Bonded anchors’.
2. Technický a zkušební ústav stavební Praha, s.p. is authorised to check whether the provisions of this European Technical Approval are met. Checking may take place in the manufacturing plant. Nevertheless, the responsibility for the conformity of the products to the European Technical Approval and for their fitness for the intended use remains with the holder of the European Technical Approval.
3. This European Technical Approval is not to be transferred to manufacturers or agents of manufacturers other than those indicated on page 1, or manufacturing plants other than those indicated on page 1 of this European Technical Approval.
4. This European Technical Approval may be withdrawn by the Technical and Test Institute for Construction Prague in particular pursuant to information by the Commission according to Article 5.1 of the Council Directive 89/106/EEC.
5. Reproduction of this European Technical Approval including transmission by electronic means shall be in full. However, partial reproduction can be made with the written consent of the Technical and Test Institute for Construction Prague. In this case, partial reproduction has to be designated as such. Texts and drawings of advertising brochures shall not contradict or misuse the European Technical Approval.
6. The European Technical Approval is issued by the approval body in its official language. This version corresponds to the version circulated within EOTA. Translations into other languages have to be designated as such.

¹ Official Journal of the European Communities N° L 40, 11.02.1989, p. 12

² Official Journal of the European Communities N° L 220, 30.08.1993, p. 1

³ Official Journal of the European Union no. L 284, 31.10.2003, p. 1

⁴ Collection of Law of the Czech Republic Vol.79 No190 , 21.5.2002

⁵ Official Journal of the European Communities N° L 17, 20.01.1994, p. 34

II. SPECIFIC CONDITIONS OF THE EUROPEAN TECHNICAL APPROVAL

1 Definition of product and intended use

1.1 Definition of product

The ECO-FIRST POLYVALENT polyester resin styrene-free for non-cracked concrete is bonded anchor consisting of cartridge with injection mortar and a steel element. The steel elements are the commercial threaded rods in the sizes M8 to M24 with hexagon nut and washer. The steel elements are made of galvanized steel or stainless steel.

The steel element is placed into a drilled hole filled with injection mortar and is anchored via the bond between metal part, injection mortar and concrete.

The installed anchor is shown in Annex 1.

1.2 Intended use

The anchor is intended to be used for anchorages for which requirements for mechanical resistance and stability and safety in use in sense of the Essential Requirements 1 and 4 of Council Directive 89/106/EEC shall be fulfilled and failure of anchorages made with these products would compromise the stability of the works, cause risk to human life and/or lead to considerable economic consequence.

Safety in case of fire (Essential Requirement 2) is not covered in this ETA. The anchor is to be used only for anchorages subject to static or quasistatic loading in reinforced or unreinforced normal weight concrete of strength class C20/25 at minimum and C50/60 at maximum according EN 206-1:2000-12.

The anchor may be used in non-cracked concrete only.

The anchor may be installed in dry or wet concrete (use category 1)

The anchor may be used in the following temperature ranges:
-40°C to +40°C (max long term temperature +24°C,
max short term temperature +40°C)

Elements made of galvanized steel:

The element made of galvanized steel may only be used in structures subject to dry internal conditions.

Elements made of stainless steel A4:

The element made of stainless steel may be used in structures subject to dry internal conditions and also in structures subject to external atmospheric exposure (including industrial and marine environmental), or exposure to permanently damp internal conditions, if no particular aggressive conditions exist. Such particular aggressive conditions are e.g. permanent, alternating immersion in seawater or the splash zone of seawater, chloride atmosphere of indoor swimming pools or atmosphere with extreme chemical pollution (e.g. in desulphurization plants or road tunnels where deicing materials are used).

The provisions made in this European Technical Approval are based on an assumed working life of the anchor of 50 years. The indications given on the working life cannot be interpreted as a guarantee given by the producer, but are to be regarded only as a means for choosing the products in relation to the expected economically reasonable working life of the works.

2 Characteristics of the product and methods of verification

2.1 Characteristics of the product

The anchors correspond to the drawings and information give in Annexes 1 and 4. The characteristic material values, dimensions and tolerances of the anchor not indicated in Annexes 1 and 4 shall correspond to the respective values laid down in the technical documentation⁶ of this European Technical Approval.

The characteristic values of ECO-FIRST POLYVALENT for the design of the anchorages are given in Annexes 7 - 8.

Each mortar cartridge is to be marked with the producer name, trade name, shelf-life and curing and processing time.

The ECO-FIRST POLYVALENT bonded anchor is intended to be used with commercial standard threaded rods according to Annex 1 and 3.

- Mechanical properties according to EN ISO 898-1
- Quality affirmation of the mechanical properties with an inspection document according to EN 10204:2004
- Marking of the threaded rod with the embedment depth. This may be done by the manufacturer of the rod or the person on job site.

The two components of the injection mortar are delivered in unmixed condition in coaxial and pre-mix cartridges in small sizes 150 ml, 280 ml, 300 ml to 330 ml and in big sizes 380 ml to 420 ml, in side-by-side cartridges 235 ml, 345 ml and 825 ml and in foil tube cartridges in sizes 165 ml and 300 ml according Annex 2.

2.2 Methods of verification

The assessment of the fitness of the anchor for the intended use in relation to the requirements for safety in use in the sense of Essential Requirement 1 and 4 has been made in compliance with the Guideline for European Technical Approval of "Metal anchors for use in concrete ", ETAG 001, Part 1 "Anchors in general" and Part 5 "Bonded anchors", on the basis of Option 7.

In addition to the specific clauses relating to dangerous substances contained in this European Technical Approval, there may be other requirements applicable to the products falling within its scope (e.g. transposed European legislation and national laws, regulations and administrative provisions). In order to meet the provisions of the UE Construction Products Directive, these requirements need also to be complied with, when and where they apply.

3 Evaluation of conformity of the product and CE marking

3.1 System of attestation of conformity

The system of attestation of conformity is the system 1 described in Council Directive 89/106/EEC Annex III, 2(i), as follows:

Certification of conformity of the product by a Notified Body based on:

- (a) Tasks of the manufacturer:
 - (1) factory production control,
 - (2) testing of samples taken at the factory by the manufacturer in accordance with a prescribed control plan.
- (b) Tasks of the approved body:
 - (3) initial type-testing of the product,
 - (4) initial inspection of factory and of factory production control,
 - (5) continuous surveillance, assessment and approval of factory production control.

⁶ The technical documentation of this European Technical Approval is deposited at the Technický a zkušební ústav stavební Praha, s.p, as far as relevant for the tasks of the approved bodies involved in the attestation of conformity producer, is handed over to the approved bodies.

3.2 Responsibility

3.2.1 Tasks of the manufacturer

3.2.1.1 Factory production control

The manufacturer shall exercise permanent internal control of production. All the elements, requirements and provisions adopted by the manufacturer shall be documented in a systematic manner in the form of written policies and procedures, including records of results performed. This production control system shall insure that the product is in conformity with this European Technical Approval.

The manufacturer may only use raw materials stated in the technical documentation of this European Technical Approval.

The factory production control shall be in accordance with the control plan which is a part of the technical documentation of this European Technical Approval. The control plan is laid down in the context of the factory production control system operated by the manufacturer and deposited at TTÚS Praha, s.p.⁷.

The results of factory production control shall be recorded and evaluated in accordance with the provisions of the control plan.

3.2.1.2 Other tasks of manufacturer

The manufacturer shall, on the basis of a contract, involve a body which is approved for the tasks referred to in section 3.1 in the field of anchors in order to undertake the actions laid down in section 3.2.2. For this purpose, the control plan referred to in sections 3.2.1.1 and 3.2.2 shall be handed over by the manufacturer to the approved body involved.

The manufacturer shall make a declaration of conformity, stating that the construction product is in conformity with the provisions of this European Technical Approval.

3.2.2 Tasks of the approved body

The approved body shall perform the:

- initial type-testing of the product
- initial inspection of factory and of factory production control
- continuous surveillance, assessment and approval of factory production control

in accordance with the provisions laid down in the control plan.

The approved body shall retain the essential points of its actions referred to above and state the results obtained and conclusions drawn in a written report.

The approved certification body involved by the manufacturer shall issue an EC certificate of conformity of the product stating the conformity with the provisions of this European Technical Approval.

In cases where the provisions of the European Technical Approval and its control plan are no longer fulfilled the certification body shall withdraw the certificate of conformity and inform Technický a zkušební ústav stavební Praha, s.p. without delay.

3.3 CE marking

The CE-marking⁸ shall be affixed on each packaging of the anchor. The symbol "CE" shall be accompanied by the following information:

- name or identifying mark of producer and manufacturing plant;
- the last two digits of the year in which the CE-marking was affixed;

⁷ The control plan is a confidential part of the documentation of the European Technical Approval, but not published together with the ETA and only handed over to the approved body involved in the procedure of attestation of conformity. See section 3.2.2.

⁸ Notes on the CE marking are stated in Guidance Paper D „CE marking under the Construction Products Directive“, Brussels, 01 August 2002

- identification number of an approved body;
- number of the EC certificate of conformity;
- number of the European Technical Approval;
- use category (ETAG 001-1, Option 7).

4 Assumptions under which the fitness of the product for the intended use was favourably assessed

4.1 Manufacturing

The anchor is manufactured in accordance with the provisions of the European Technical Approval using the automated manufacturing process as verified by the inspection of the plant performed by the Technický a zkušební ústav stavební Praha, s.p. as laid down in the technical documentation.

4.2 Installation

4.2.1 Design of anchorages

The fitness of the anchors for the intended use is given under the following conditions:

The anchorages are designed in accordance with the EOTA Technical Report TR 029 "Design of bonded anchors" under the responsibility of an engineer experienced in anchorages and concrete work.

Verifiable calculation notes and drawings are prepared taking account of the loads to be anchored.

The position of the anchor is indicated on the design drawings (e.g. position of the anchor relative to reinforcement or to support, etc.).

4.2.2 Installation of anchor

The fitness for use of the anchor can only be assumed if the following conditions of installation are met:

- anchor installation carried out by appropriately qualified personnel under the supervision of the person responsible for technical matters on site;
- use of the anchor only as supplied by the manufacturer without exchanging any components of the anchor; commercial standard threaded rods, washers and hexagon nuts may be used if the following requirements are fulfilled:
 - Material, dimensions and mechanical properties according Annex 3
 - Confirmation of material and mechanical properties by inspection certificate 3.1 according to EN 10204:2004,
 - Marking of threaded rod with the envisage embedment depth. This may be done by the manufacturer of the rod or the person on job site
- anchor installation in accordance with the manufacturer's specifications and drawings using the tools indicated in this European Technical Approval;
- checks before placing the anchor to ensure that the strength class of the concrete in which the anchor is to be placed is in the range;
- check of the concrete being well compacted, e.g. without significant voids;
- keeping the effective anchorage depth;
- edge distance and spacing not less than the specified values without minus tolerance;
- placing drill holes without damaging the reinforcement;
- in case of aborted drill hole, the drill hole shall be filled with mortar;
- the hole shall not be filled with water;
- cleaning the drill hole by following: at least 4 x blowing, 4 x brushing, 4 x blowing. To cleaning shall be used brush according Annex 4 Table 2;

- anchor installation ensuring the specified embedment depth, that is the appropriate depth marking of the anchor not exceeding the concrete surface;
- mortar injection by using the equipment including the special static mixer shown in Annex 2, discarding out separately a minimum the first portion of mortar of each new cartridge until the mortar shows a consistent grey colour; taking from the manufacturer instruction the admissible processing time (open time) of a cartridge as a function of the ambient temperature of the concrete; filling the drill hole uniformly from the drill hole bottom, slowly withdraw the static mixer as the hole fills to avoid creating air pocket; filling the drill hole up to approximately 2/3 with adhesive; inserting immediately the threaded rod, slowly and with a slight twisting motion until the embedment depth is reached, removing excess of injection mortar around the rod; observing the curing time according to Annex 6 table 4 until the rod may be loaded;
- during curing of the injection mortar the temperature of the concrete must not fall below -5°C;
- application of the torque moment given in Annex 4 table 3 using calibrated torque wrench.

4.2.3 Responsibility of the manufacturer

It is in the responsibility of the manufacturer to ensure that the information on the specific conditions according to (1) and (2) including Annexes referred to 4.2.1, 4.2.2 is given to those who are concerned. This information may be made by reproduction of the respective parts of the European Technical Approval. In addition, all installation data shall be shown clearly on the packaging and/or on an enclosed instruction sheet, preferably using illustration(s).

The minimum data required for manual are:

- drill bit diameter,
- thread diameter,
- maximum thickness of the fixture,
- minimum installation depth,
- required torque moment,
- admissible installation temperature range,
- curing time of the bonding material depending on the installation temperature,
- information on the installation procedure, include cleaning of the hole,
- reference to any special installation equipment needed,
- identification of the manufacturing batch,

All data shall be presented in a clear and explicit form.

5 Recommendations for the manufacturer

5.1 Recommendations on packaging, transportation and storage

The mortar cartridges shall be protected against sun radiation and shall be stored according to the manufacturer's instructions in dry conditions.

ECO-FIRST POLYVALENT shall be stored at temperatures of at least +5°C to not more than +25°C.

Mortar cartridges with expired shelf life must no longer be used.

Ing. Jana Čurdová
Head of the Approval Body

**Threaded rod M8, M10, M12, M16, M20, M24
with washer and hexagon nut**

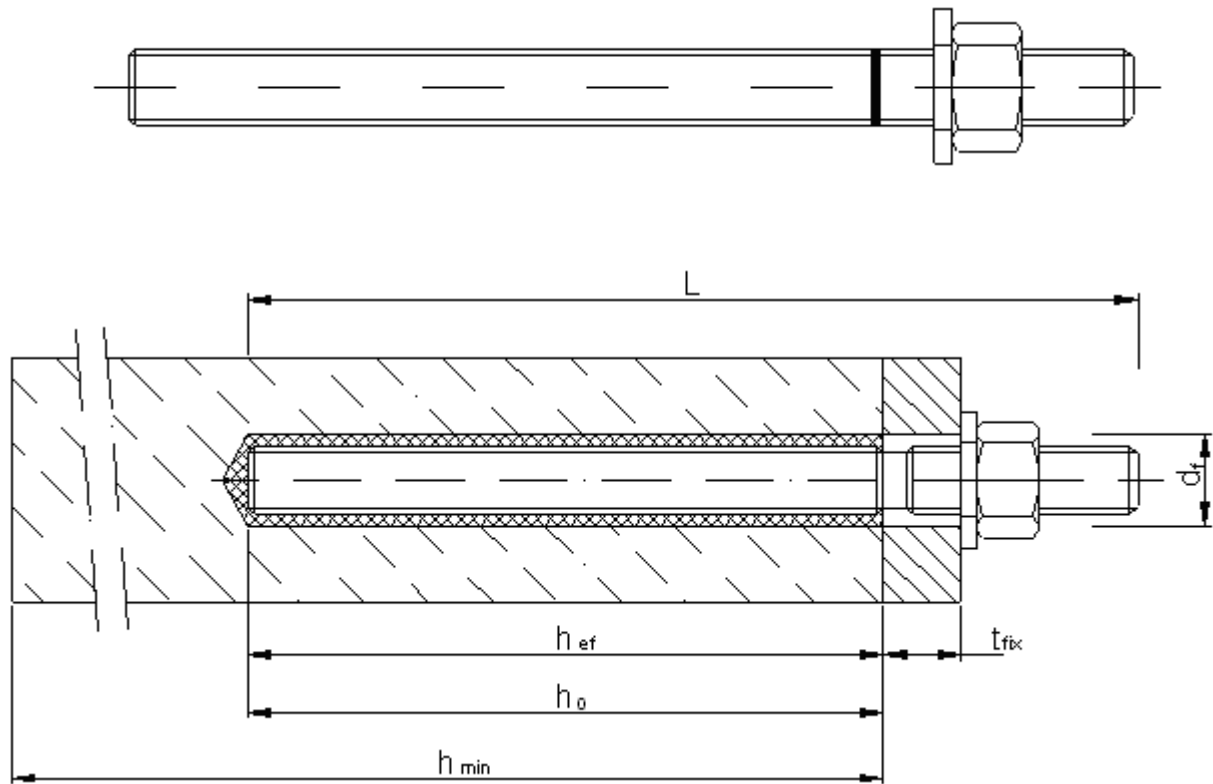

Injection system ECO-FIRST POLYVALENT

Product and Installation

Annex 1

of European
Technical Approval
ETA-11/0444

Cartridge: ECO-FIRST POLYVALENT

150 ml, 280 ml, 300 ml, 380 ml, 410 ml and 420 ml cartridge (Type: coaxial)

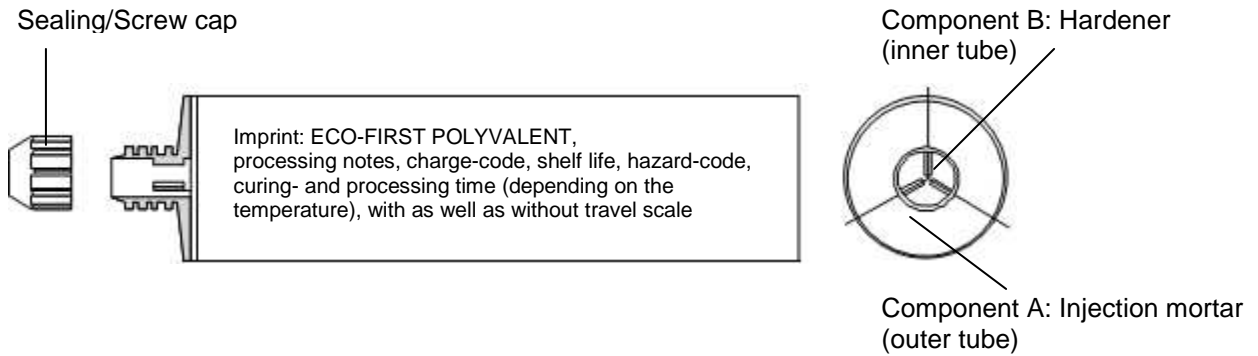

235 ml, 345 ml and 825 ml cartridge (Type: “side-by-side”)

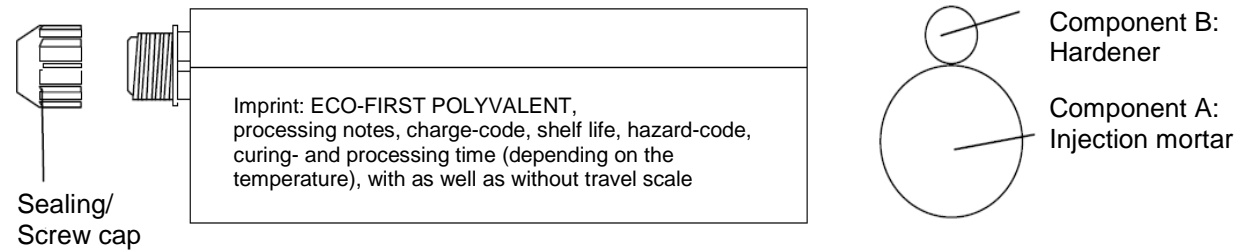

165 ml and 300 ml cartridge (Type: “foil tube”)

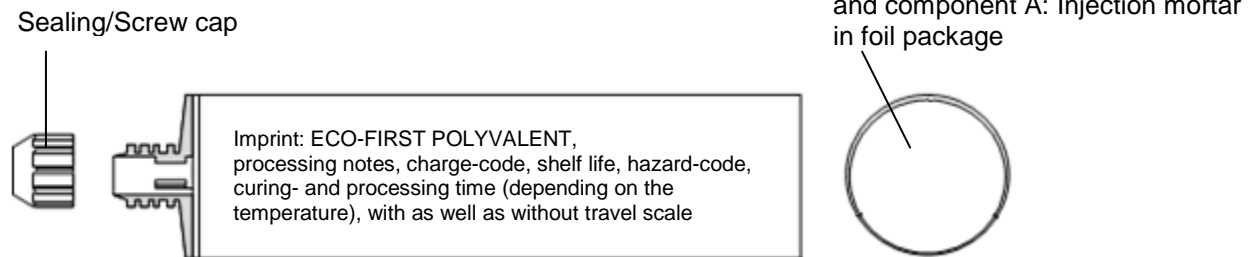

Static mixer

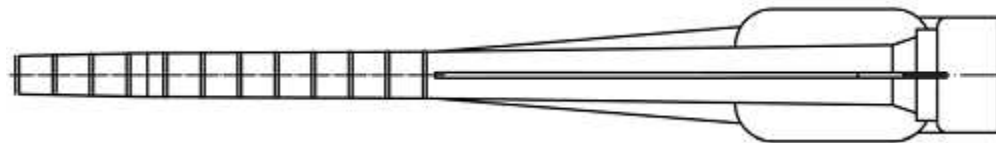

Use category:

- Installation in dry and wet concrete
- Overhead installation

Temperature range:
 -40°C to +40°C (max. short. Term temperature +40°C and max. long term temperature +24°C)

Injection system ECO-FIRST POLYVALENT

Product (injection mortar) and Intended use

Annex 2

of European
 Technical Approval
 ETA-11/0444

Table 1: Materials (Threaded rod)

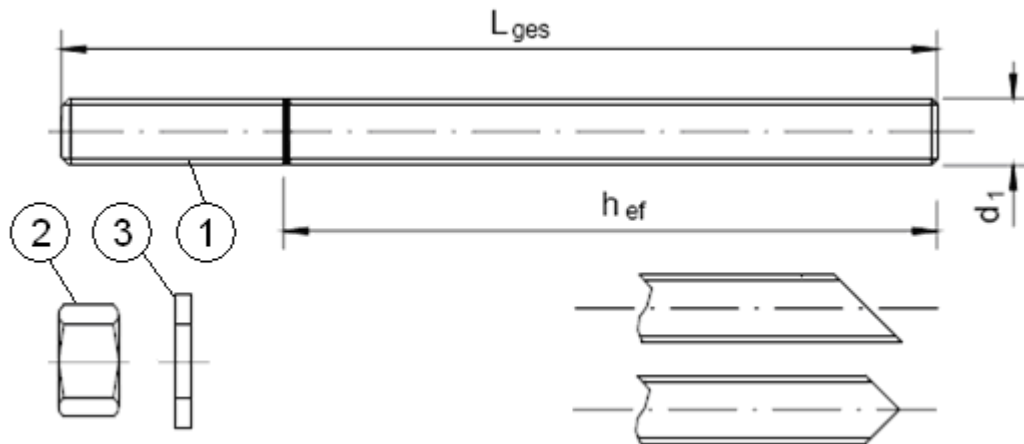

Part	Designation	Material
Steel, zinc plated $\geq 5 \mu\text{m}$ acc. to EN ISO 4042 or Steel, Hot-dip galvanized $\geq 40 \mu\text{m}$ acc. to EN ISO 1461 and EN ISO 10684		
1	Anchor rod	Steel, EN 10087 or EN 10263 Property class 4.8, 5.8, EN ISO 898-1:1999
2	Hexagon nut, EN ISO 4032	EN 20898-2
3	Washer, EN ISO 887, EN ISO 7089, EN ISO 7093 or EN ISO 7094	Steel, zinc plated or hot-dip galvanised
Stainless steel		
1	Anchor rod	Material: A4-70, A4-80, EN ISO 3506
2	Hexagon nut, EN ISO 4032	Material: A4-70, A4-80, EN ISO 3506
3	Washer, EN ISO 887, EN ISO 7089, EN ISO 7093 or EN ISO 7094	Material: A4-70, A4-80, EN ISO 3506

Injection system ECO-FIRST POLYVALENT

Materials (threaded rod)

Annex 3

of European
 Technical Approval
 ETA-11/0444

Table 2: Cleaning

Size		M8	M10	M12	M16	M20	M24
Nominal drill hole diameter	$\varnothing d_0$ [mm]	10	12	14	18	24	28
Diameter of brush	d_b [mm]	12,0	14,0	16,3	20,0	26,0	30,0
Minimum brush diameter	$d_{b,min}$ [mm]	10,5	12,5	14,5	18,5	24,5	28,5
Brush length	L [mm]	170	170	170	200	250	300
Cleaning		4 x blow out 4 x brush out 4 x blow out					

Table 3: Installation parameter

Size		M8	M10	M12	M16	M20	M24
Nominal drill hole diameter	$\varnothing d_0$ [mm]	10	12	14	18	24	28
Depth of drill hole	h_0 [mm]	80	90	110	125	170	210
Edge distance	$C_{cr,N}$ [mm]	80	90	110	125	170	210
Minimum edge distance	C_{min} [mm]	40	50	60	80	100	120
Spacing	$S_{cr,N}$ [mm]	160	180	220	250	340	420
Minimum spacing	S_{min} [mm]	40	50	60	80	100	120
Minimum thickness of member	h_{min} [mm]	110	120	140	160	215	260
Torque moment	T_{inst} [Nm]	10	20	40	60	120	150

Steel brush



Hand pump (volume 750 ml)

Drill bit diameter (d_0): 10 mm to 20 mm



Injection system ECO-FIRST POLYVALENT

Installation parameters
 Cleaning and setting tools

Annex 4

of European
 Technical Approval
 ETA-11/0444

Assembly instructions

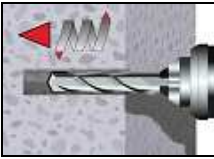

1. Drill with hammer drill a hole into the base material to the size and embedment depth required by the selected anchor (Table 3).

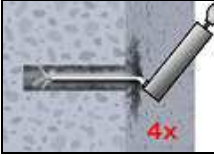

Attention! Standing water in the bore hole must be removed before cleaning.

- 2a. Starting from the bottom or back of the bore hole, blow the hole clean with compressed air or a hand pump (Annex 4) a minimum of four times. If the bore hole ground is not reached an extension shall be used.

The hand-pump can be used for anchor sizes up to bore hole diameter 20 mm.



For bore holes larger than 20 mm or deeper 240 mm, compressed air (min. 6 bar) **must** be used.

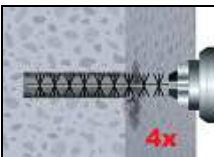

- 2b. Check brush diameter (Table 2) and attach the brush to a drilling machine or a battery screwdriver. Brush the hole with an appropriate sized wire brush $> d_{b,min}$ (Table 2) a minimum of four times. If the bore hole ground is not reached with the brush, a brush extension shall be used (Table 2).



- 2c. Finally blow the hole clean again with compressed air or a hand pump (Annex 4) a minimum of four times. If the bore hole ground is not reached an extension shall be used.

The hand-pump can be used for anchor sizes up to bore hole diameter 20 mm. For bore holes larger than 20 mm or deeper 240 mm, compressed air (min. 6 bar) **must** be used.



After cleaning, the bore hole has to be protected against re-contamination in an appropriate way, until dispensing the mortar in the bore hole. If necessary, the cleaning repeated has to be directly before dispensing the mortar. In-flowing water must not contaminate the bore hole again

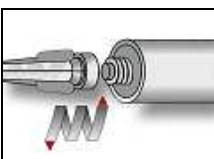

3. Attach a supplied static-mixing nozzle to the cartridge and load the cartridge into the correct dispensing tool. Cut off the foil tube clip before use. For every working interruption longer than the recommended working time (Table 4) as well as for new cartridges, a new static-mixer shall be used.

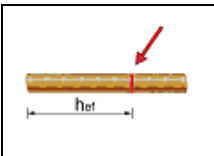

4. Prior to inserting the anchor rod into the filled bore hole, the position of the embedment depth shall be marked on the anchor rods

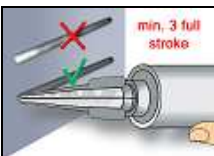

5. Prior to dispensing into the anchor hole, squeeze out separately a minimum of three full strokes and discard non-uniformly mixed adhesive components until the mortar shows a consistent grey colour.

Injection system ECO-FIRST POLYVALENT

Annex 5

Assembly instructions

of European
 Technical Approval
 ETA-11/0444

Assembly Instructions (continuation)

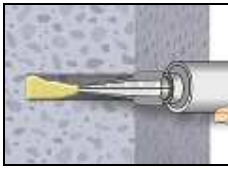

6. Starting from the bottom or back of the cleaned anchor hole fill the hole up to approximately two-thirds with adhesive. Slowly withdraw the static mixing nozzle as the hole fills to avoid creating air pockets. For embedment larger than 190 mm an extension nozzle shall be used. Observe the gel-/ working times given in Table 4.

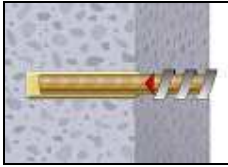

7. Push the threaded rod or reinforcing bar into the anchor hole while turning slightly to ensure positive distribution of the adhesive until the embedment depth is reached.

The anchor should be free of dirt, grease, oil or other foreign material.

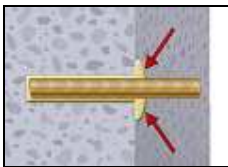

8. Be sure that the anchor is fully seated at the bottom of the hole and that excess mortar is visible at the top of the hole. If these requirements are not maintained, the application has to be renewed.

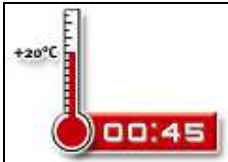

9. Allow the adhesive to cure to the specified time prior to applying any load or torque. Do not move or load the anchor until it is fully cured (attend Table 4).

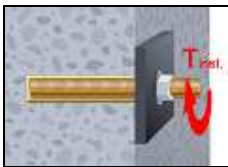

10. After full curing, the add-on part can be installed with the max. torque (Table 3) by using a calibrated torque wrench.

Table 4: Minimum curing time

Temperature of base material [°C]	Gelling and working time [min]	Full curing time [min]
-5 to 0	90	360
0 to +5	45	180
+5 to +10	25	120
+10 to +20	15	80
+20 to +30	6	45
+30 to +35	4	25
+35	2	20

Injection system ECO-FIRST POLYVALENT

Assembly instructions (continuation)
 Curing time

Annex 6

of European
 Technical Approval
 ETA-11/0444

Table 5: Design method TR 029
Characteristic values of resistance to tension load

Steel failure – Characteristic resistance								
Size			M8	M10	M12	M16	M20	M24
Steel grade 4.8	$N_{Rk,s}$	[kN]	15	23	34	63	98	141
Partial safety factor	γ_{Ms}	[-]	2*					
Steel grade 5.8	$N_{Rk,s}$	[kN]	18	29	42	79	123	177
Partial safety factor	γ_{Ms}	[-]	1,5*					
Stainless steel grade A4-70	$N_{Rk,s}$	[kN]	26	41	59	110	172	247
Partial safety factor	γ_{Ms}	[-]	1,9*					
Stainless steel grade A4-80	$N_{Rk,s}$	[kN]	29	46	67	126	196	282
Partial safety factor	γ_{Ms}	[-]	1,6*					

Combined pullout and concrete cone failure in non-cracked concrete C20/25								
Size			M8	M10	M12	M16	M20	M24
Characteristic resistance in non-cracked concrete	$N_{Rk,p}$	[kN]	16	35	35	50	75	95
Partial safety factor	γ_{Mc}	[-]	1,8*					
Factor for concrete	C30/37	ψ_c	[-]	1,08				
	C40/50			1,15				
	C50/60			1,19				

Splitting failure								
Size			M8	M10	M12	M16	M20	M24
Edge distance	$c_{cr,sp}$	[mm]	120	135	165	188	255	315
Spacing	$s_{cr,sp}$	[mm]	240	270	330	375	510	630
Partial safety factor	γ_{Msp}	[-]	1,8*					

* - in absence of other national regulation

Injection system ECO-FIRST POLYVALENT

Design method TR 029
 Characteristic values of resistance to tension load

Annex 7

of European
 Technical Approval
 ETA-11/0444

Table 6: Design method TR 029
Characteristic values of resistance to shear load

Steel failure without lever arm			M8	M10	M12	M16	M20	M24
Size								
Steel grade 4.8	$V_{Rk,s}$	[kN]	7	12	17	31	49	71
Partial safety factor	γ_{Ms}	[-]	1,67*					
Steel grade 5.8	$V_{Rk,s}$	[kN]	9	15	21	39	61	88
Partial safety factor	γ_{Ms}	[-]	1,25*					
Stainless steel grade A4-70	$V_{Rk,s}$	[kN]	13	20	30	55	86	124
Partial safety factor	γ_{Ms}	[-]	1,56*					
Stainless steel grade A4-80	$V_{Rk,s}$	[kN]	15	23	34	63	98	141
Partial safety factor	γ_{Ms}	[-]	1,33*					

Steel failure with lever arm			M8	M10	M12	M16	M20	M24
Size								
Steel grade 4.8	$M^o_{Rk,s}$	[kN]	15	30	52	133	260	449
Partial safety factor	γ_{Ms}	[-]	1,66*					
Steel grade 5.8	$M^o_{Rk,s}$	[kN]	19	37	66	166	325	561
Partial safety factor	γ_{Ms}	[-]	1,25*					
Stainless steel grade A4-70	$M^o_{Rk,s}$	[kN]	26	52	92	233	454	786
Partial safety factor	γ_{Ms}	[-]	1,56*					
Stainless steel grade A4-80	$M^o_{Rk,s}$	[kN]	30	60	105	266	519	898
Partial safety factor	γ_{Ms}	[-]	1,33*					

Concrete pryout failure			M8	M10	M12	M16	M20	M24
Size								
Factor <i>k</i> from TR 029			2					
Design of bonded anchors, Part 5.2.3.3								
Partial safety factor	γ_{Mp}	[-]	1,5*					

Concrete edge failure								
See section 5.2.3.4 of Technical Report TR 029 for the Design of Bonded Anchors								
Partial safety factor	γ_{Mc}	[-]	1,5*					

* - in absence of other national regulations

Table 7: Displacement under tension and shear load

Anchor size			M8	M10	M12	M16	M20	M24
Tension load	F	[kN]	6,3	13,9	13,9	19,8	29,8	37,7
Displacement	δ_{N0}	[mm]	0,3	0,3	0,3	0,4	0,5	0,6
Shear load	F	[kN]	4,2	6,6	9,6	17,9	28,0	40,3
Displacement	δ_{V0}	[mm]	0,3	0,3	0,5	0,7	0,9	1,2
	$\delta_{V\infty}$	[mm]	0,5	0,5	0,8	1,1	1,4	1,8

Injection system ECO-FIRST POLYVALENT

Design method TR 029
Characteristic values of resistance to shear load
Displacement

Annex 8

of European
Technical Approval
ETA-11/0444